



# Concepts™ Serving Systems

Cashier Counter

Project \_\_\_\_\_

Item \_\_\_\_\_

Quantity \_\_\_\_\_

CSI Section 11400

Approved \_\_\_\_\_

Date \_\_\_\_\_

Concepts™ Serving Systems: Cashier Counter

## Models

- DCCS-SD Single drawer
- DCCS-SDW Single drawer with wing walls
- DCCS-SDWL Single drawer with left wing wall
- DCCS-SDWR Single drawer with right wing wall
- DCCS-DD Dual drawer
- DCCS-DDW Dual drawer with wing walls
- DCCS-DDWL Dual drawer with left wing wall
- DCCS-DDWR Dual drawer with right wing wall

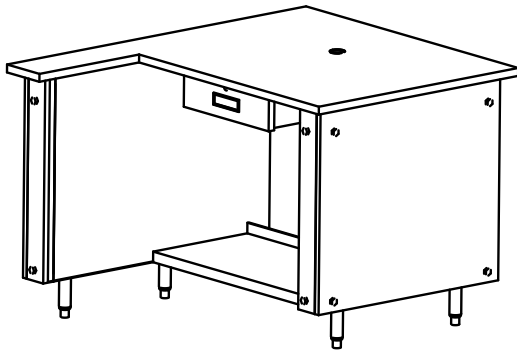

DCCS-SDWL

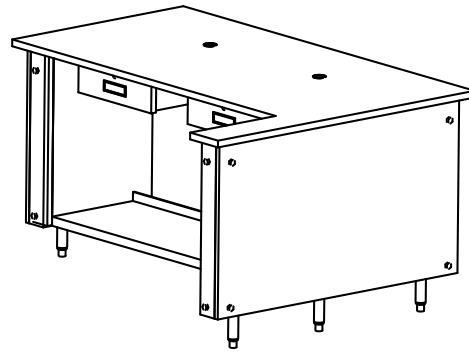

DCCS-DDWR

## Standard Features

- Heavy duty stainless steel top
- Reinforced stainless steel front and rear removable panels
- Heavy duty base support structure
- Standard on 6" legs
- 2" grommet hole in top to allow cord access for cash registers
- Stainless steel locking cash drawer(s) standard
- 120V-15A duplex (GFCI) receptacle, Nema 5-15R 15.0A breaker
- Finished stainless steel or laminated end panels
- 36" work height
- One year parts and labor standard warranty

## Options & Accessories

- Granite, Hanstone and Solid Surface top materials
- Laminated base panels
- Décor panels
- Graphics packages
- Casters
- Kickplates (units with legs only)
- 34" work height
- 30" work height



## DCCS-SD

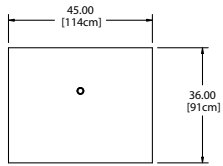

DCCS-SD Plan View

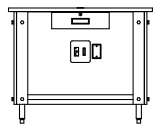

DCCS-SD Elevation View

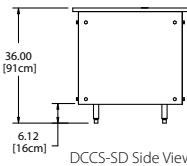

DCCS-SD Side View

## DCCS-SDW

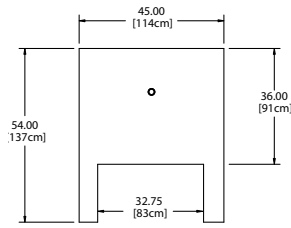

DCCS-SDW Plan View

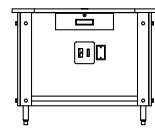

DCCS-SDW Elevation View

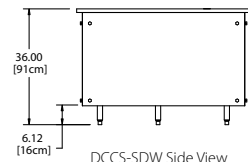

DCCS-SDW Side View

## DCCS-SDWL

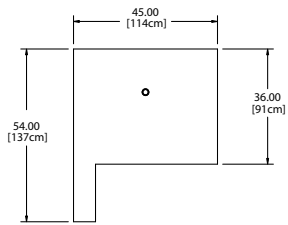

DCCS-SDWL Plan View

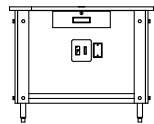

DCCS-SDWL Elevation View

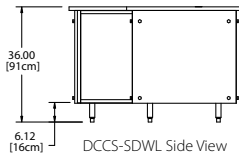

DCCS-SDWL Side View

## DCCS-SDWR

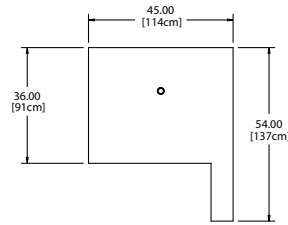

DCCS-SDWR Plan View

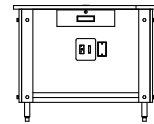

DCCS-SDWR Elevation View

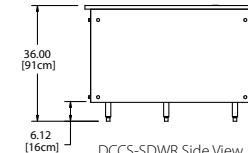

DCCS-SDWR Side View

## DCCS-DD

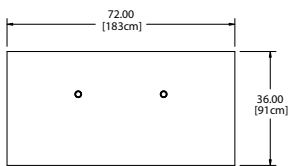

DCCS-DD Plan View

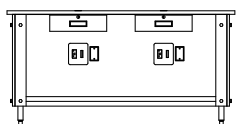

DCCS-DD Elevation View

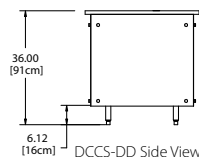

DCCS-DD Side View

## DCCS-DDW

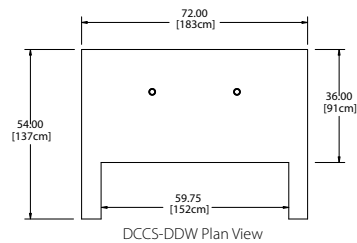

DCCS-DDW Plan View

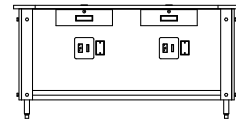

DCCS-DDW Elevation View

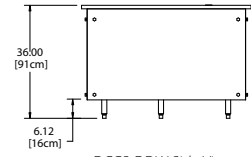

DCCS-DDW Side View

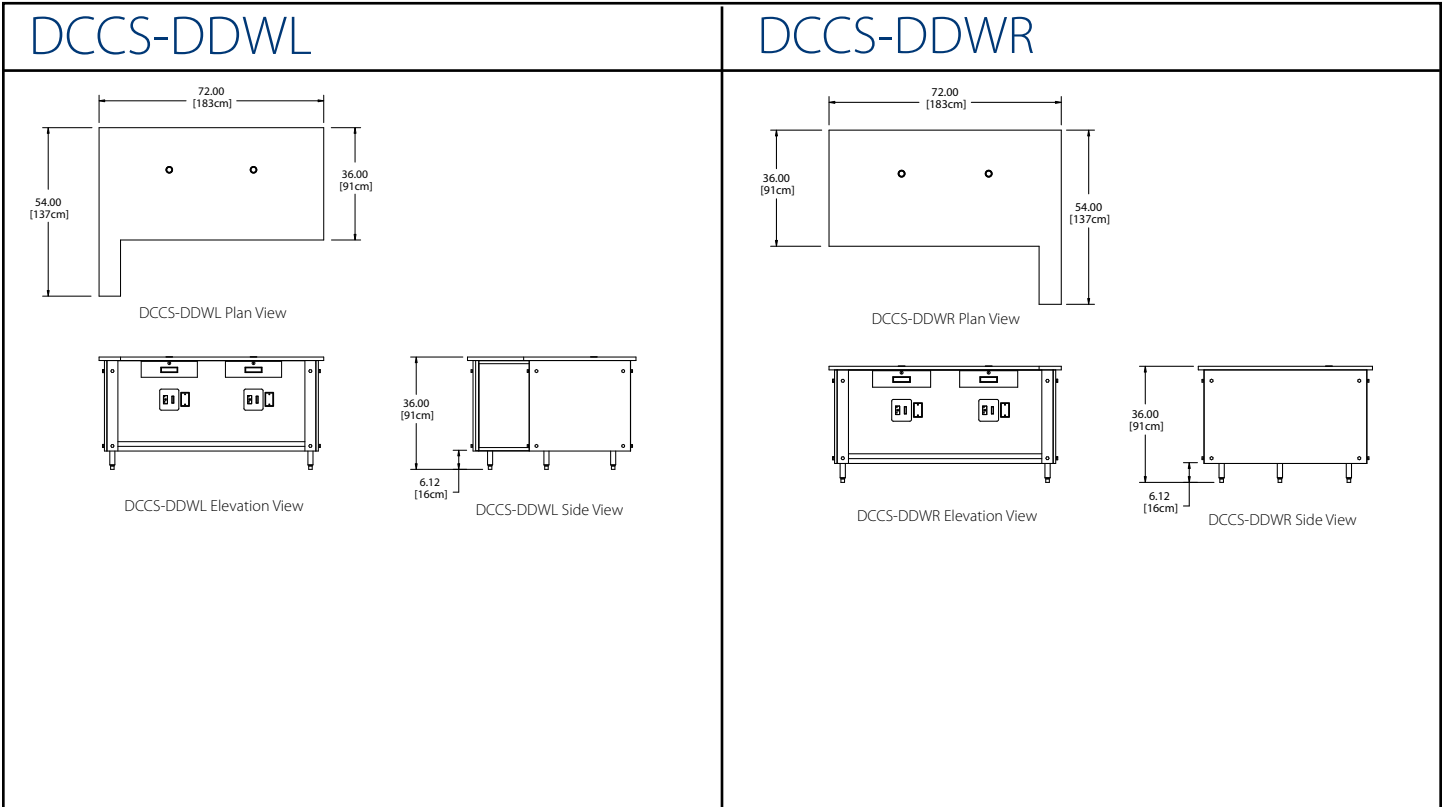

## Concepts™ Serving Systems

Specifications				
Model	Length	Width	Height	Ship Weight
DCCS-SD	45.00"	36.00"	36.00"	270lbs/122kg
DCCS-SDW	45.00"	54.00"	36.00"	320lbs/145kg
DCCS-SDWL	45.00"	54.00"	36.00"	295lbs/134kg
DCCS-SDWR	45.00"	54.00"	36.00"	295lbs/134kg
DCCS-DD	72.00"	36.00"	36.00"	540lbs/245kg
DCCS-DDW	72.00"	54.00"	36.00"	590lbs/268kg
DCCS-DDWL	72.00"	54.00"	36.00"	565lbs/256kg
DCCS-DDWR	72.00"	54.00"	36.00"	565lbs/256kg

Delfield reserves the right to make changes to the design or specifications without prior notice.



# Concepts™ Serving Systems

Cashier Counter

## Specifications

**Exterior body** is constructed of 0.75" Melamine reinforced front and rear panels with 22 gauge stainless steel skin and 1" polyethylene horizontal rib supports. Horizontal brace on rear is constructed of 18 gauge galvanized steel. The exterior ends are unfinished.

**Exterior top** is constructed of 14 gauge stainless steel. Horizontal top supports on front and rear are constructed with 18 gauge galvanized steel. Top end supports are 12 gauge stainless steel.

**Interior base** bottom is constructed of 16 gauge galvanized steel. Vertical base support braces are 14 gauge galvanized steel.

**Legs:** Bases mounted on 6.12" adjustable legs.

**Electrical:** 120V-15A duplex (GFCI) receptacle. Nema 5-15R 15.0A breaker.

